

TDF series for Mobile & Cordless Phone

SELECTION GUIDE FOR STANDARD DEVICES

- The Part Numbers shown in the table below are standard devices, which are readily available. TOKO will design and manufacture modified and custom devices with specific characteristics to meet your requirements. If you do not find the device for your application in this catalog, please contact our sales or representative office.
- RoHS compliant

- 下記の表に示す製品番号は、標準品です。TOKOは、お客様のご要望に合わせて設計、製作いたしますので、お客様の用途に適合する仕様が見当たらない場合は、当社営業所または代理店にご連絡ください。
- RoHS指令対応

東光品番	中心周波数	帯域幅	挿入損失	V.S.W.R.	選択度	外形寸法	用途	個数/リール
TOKO Part Number	Center Frequency (MHz)	Bandwidth (MHz)	Insertion Loss (dB) Max.	V.S.W.R. in BW Max.	Selectivity (dB) Min. (MHz)	Dimension (mm) W × L × T (Max.)	Application	Pcs/Reel
TDF2A-836E-10A	836.5	Fo ± 12.5	2.70	2.00	6 (Fo ± 32.5)	5.7 × 9.9 × 2.25	US Cellular	1500
TDF2A-881E-10A	881.5	Fo ± 12.5	2.70	2.00	6 (Fo ± 32.5)	5.7 × 9.4 × 2.25	US Cellular	1500
TDFS8A-904A-11A	904.0	Fo ± 1.0	3.00	2.00	40 (Fo ± 140)	3.2 × 8.5 × 1.8	900M-CT	2000
TDFM2A-915E-10A	915.0	Fo ± 13.0	3.00	2.00	12 (Fo ± 50)	4.5 × 7.7 × 2.25	900M-CT	1500
TDFM2B-915E-10A	915.0	Fo ± 13.0	3.50	2.00	18 (Fo ± 50)	6.5 × 7.9 × 2.25	900M-CT	1500
TDFS1B-915E-10A	915.0	Fo ± 13.0	4.50	2.00	32, 25 (Fo - 77.5, + 77.5)	4.5 × 8.3 × 2.0	900M-CT	1500
TDFS8A-915E-10A	915.0	Fo ± 13.0	3.20	2.00	25, 17 (Fo - 77.5, + 77.5)	3.2 × 8.4 × 1.8	900M-CT	1500
TDFM1A-930A-12A	930.5	Fo ± 1.5	3.50	2.00	40 (Fo - 90)	4.5 × 7.5 × 2.0	PAGER	1500
TDFH5C-942G-11A-02	942.5	Fo ± 17.5	4.00	2.00	20 (Fo - 27.5)	11.5 × 8.4 × 5.5	EGSM	500
TDFM2A-1090C-11A	1090.0	Fo ± 7.0	5.50	2.50	35, 33 (Fo ± 80)	4.5 × 7.6 × 2.25	CATV	1500
TDFM1B-1747O-11A	1747.5	Fo ± 37.5	3.00	2.00	8, 25 (Fo ± 80, ± 160)	6.5 × 4.75 × 2.0	PCN	1500
TDFH5D-1842O-10A-01	1842.5	Fo ± 37.5	4.00	2.00	32 (Fo - 57.5)	14.1 × 6.6 × 5.5	PCN	500
TDFM1B-1842O-11A	1842.5	Fo ± 37.5	3.00	2.00	8, 25 (Fo ± 80, ± 160)	6.5 × 4.5 × 2.0	PCN	1500
TDFM1B-1880L-11A	1880.0	Fo ± 30.0	3.00	2.00	34, 39 (Fo ± 190, ± 240)	6.5 × 4.4 × 2.0	PCS	2000
TDFM3C-1880L-11A	1880.0	Fo ± 30.0	4.00	2.00	12 (Fo + 50)	9.0 × 6.8 × 2.8	PCS	1500
TDF3B-1900H-11A	1900.0	Fo ± 20.0	1.10	1.80	20 (Fo - 480, + 210)	6.5 × 5.3 × 3.0	PHS	1500
TDFM3A-1900H-10A	1900.0	Fo ± 20.0	1.70	1.60	12, 20 (Fo - 140, + 241)	4.5 × 3.8 × 2.8	PHS	2000
TDF3A-1907E-18A	1907.0	Fo ± 12.5	0.75	1.50	45, 15 (Fo - 486, - 237)	5.7 × 6.1 × 3.0	PHS	2000
TDF3A-1907E-19A	1907.0	Fo ± 12.5	0.65	1.50	35, 13 (Fo - 486, - 237)	5.7 × 5.9 × 3.0	PHS	2000
TDF3A-1907E-21A-01	1907.0	Fo ± 13.5	1.00	1.60	40 (Fo - 248)	5.7 × 6.25 × 2.9	PHS	2000
TDFM3A-1907E-10A	1907.0	Fo ± 12.5	1.00	1.50	40, 20 (Fo - 486, - 237)	4.5 × 3.8 × 2.8	PHS	2000
TDFM3A-1907E-11A	1907.0	Fo ± 12.0	1.60	1.50	35, 40 (Fo - 486, - 237)	4.5 × 3.8 × 2.8	PHS	2000
TDFM1B-1920V-10A	1920.0	Fo ± 70.0	2.00	2.00	25, 25 (Fo - 350, + 780)	6.5 × 4.1 × 2.0	PCS	2000
TDFM1B-1950L-10A-01	1950.0	Fo ± 30.0	3.30	2.00	25 (Fo - 230, + 160)	6.5 × 4.2 × 2.0	W-CDMA	2000
TDFH5D-1960L-11A-01	1960.0	Fo ± 30.0	4.00	2.00	32 (Fo - 50)	14.1 × 6.1 × 5.5	PCS	500
TDFM1B-1960L-11A	1960.0	Fo ± 30.0	3.00	2.00	34, 39 (Fo ± 190, ± 240)	6.5 × 4.2 × 2.0	PCS	2000
TDFM3B-1960L-13A	1960.0	Fo ± 30.0	3.30	2.00	20 (1850~1910)	6.5 × 6.0 × 2.8	PCS	1500
TDFM3C-1960L-10A	1960.0	Fo ± 30.0	4.00	2.00	12 (Fo - 50)	9.0 × 6.4 × 2.8	PCS	1500
TDFM1B-2140L-10A	2140.0	Fo ± 30.0	3.30	2.00	25 (Fo ± 160)	6.5 × 5.85 × 2.0	W-CDMA	1500

入出カインピーダンス / Input Output impedance : 50Ω

製品例

TDFM1B-1960L-11A

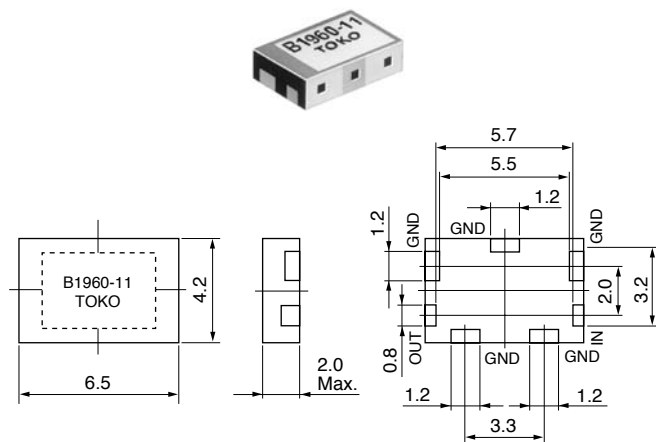

(Unit: mm)

Typical Characteristics 代表特性例

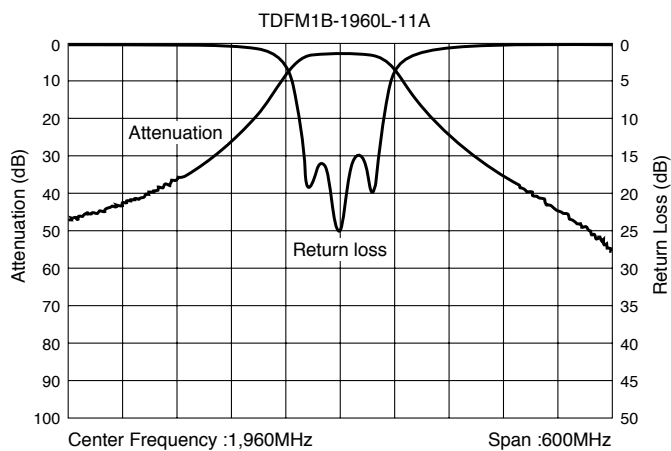

製品例

TDFS8A-915E-10A

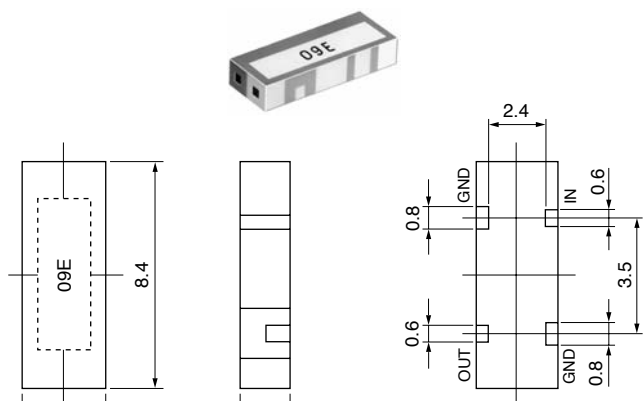

(Unit: mm)

Typical Characteristics 代表特性例

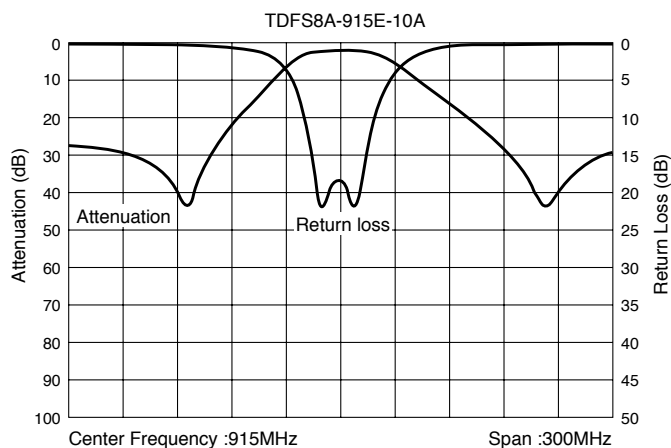

製品例

TDFM1B-2140L-10A

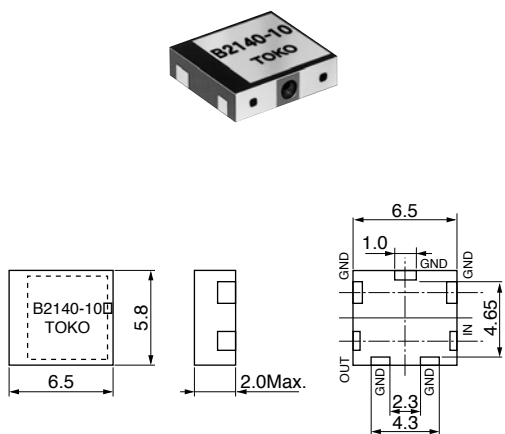

(Unit: mm)

Typical Characteristics 代表特性例

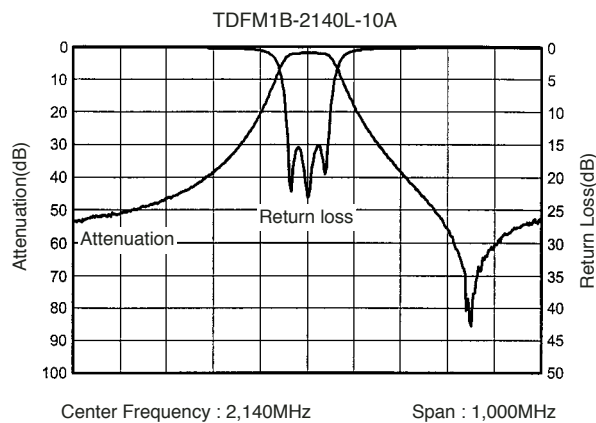

■PART NUMBERING SYSTEM / 品番構成

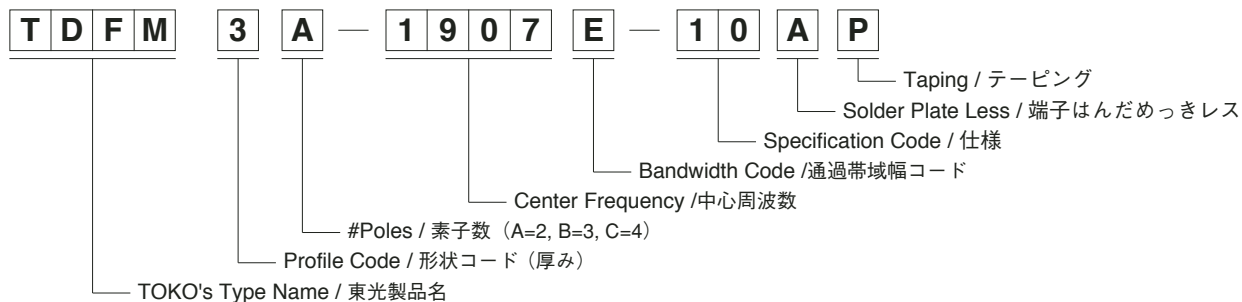

■DIMENSIONS / 外形寸法

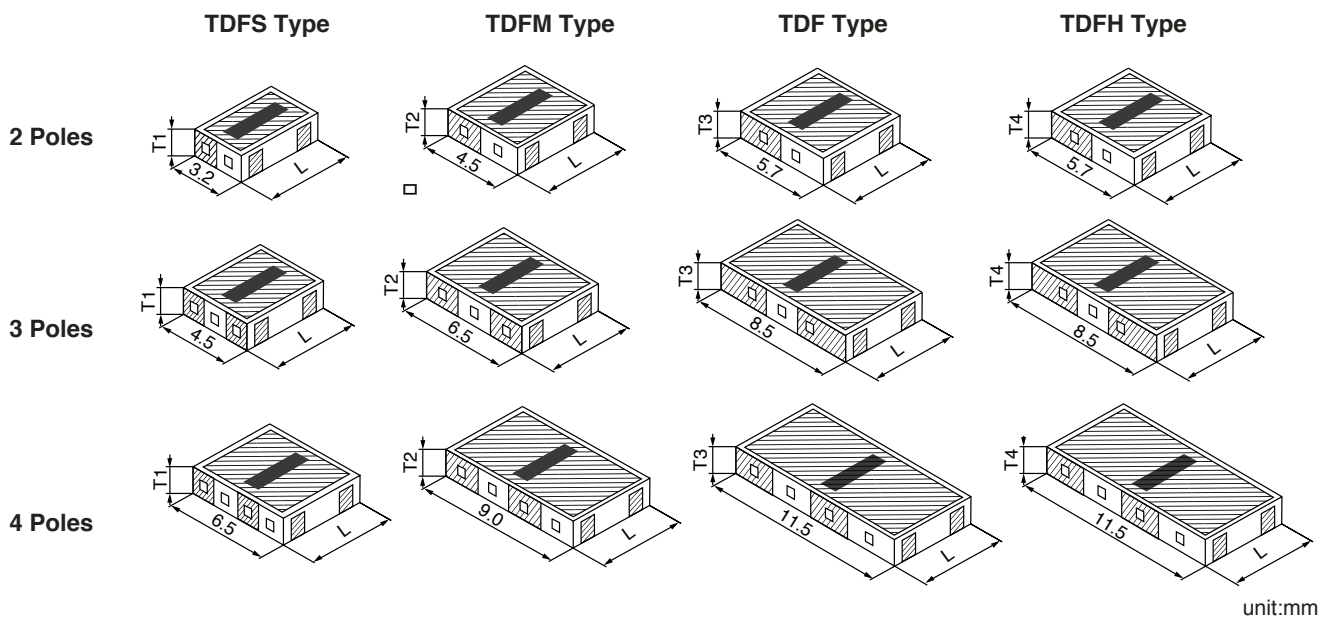

T1	T2	T3	T4
2.25 Max.	2.8 Max.	3.0 Max.	5.5 Max.
2.0 Max.	2.25 Max.	2.25 Max.	4.0 Max.
1.8 Max.	2.0 Max.	2.0 Max.	

•The length, L, is different depending on the part number.

Refer to the separate table.

長さ(L)は品番毎に異なります。

•For the details of shapes regarding individual part numbers, contact us separately.

個別品番に関する形状の詳細につきましては、別途お問い合わせ下さい。

PRECAUTIONS AND RECOMMENDED SOLDERING CONDITIONS FOR USING DIELECTRIC FILTERS SURFACE MOUNT TYPE

面実装誘電体フィルタご使用上の注意・推奨はんだ付け条件

Temperature profile (land seface temperature)
温度プロファイル (ランド部表面温度)

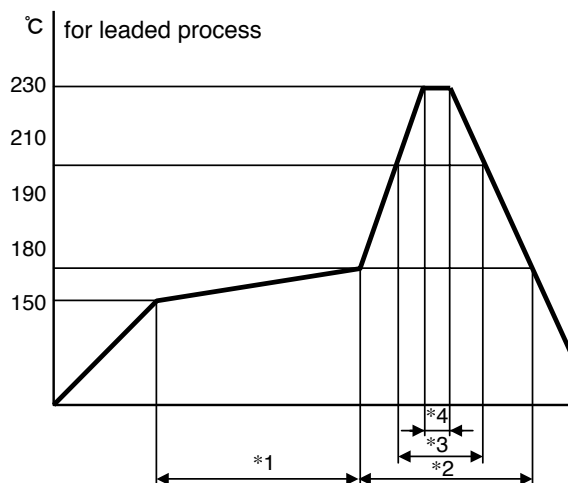

Pre-heat conditions	予熱部
*1 : 150~160°C 60s. Max.□	*1 : 150~160°C 60秒以内
Reflow conditions	リフロ部
*2 : 160°C Min. 45s. Max.	*2 : 160°C以上 45秒以内
*3 : 200°C Min. 30s. Max.	*3 : 200°C以上 30秒以内
*4 : 230±5°C 5s. Max.	*4 : 230±5°C 5秒以内

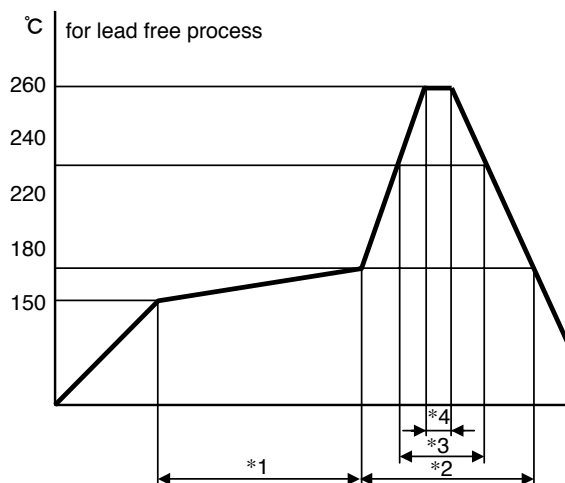

Pre-heat conditions	予熱部
*1 : 150~180°C 120s. Max.□	*1 : 150~180°C 120秒以内
Reflow conditions	リフロ部
*2 : 180°C Min. 150s. Max.	*2 : 180°C以上 150秒以内
*3 : 230°C Min. 40s. Max.	*3 : 230°C以上 40秒以内
*4 : 255±5°C 5s. Max.	*4 : 255±5°C 5秒以内

1. Reflow solder conditions

•Solderability

When flux-mounted terminals are immersed in solder at following conditions, at least 95% of the surface should be covered by solder.

Conditins

leaded process : 230±5°C for 3±0.5 seconds

lead free process : 260±5°C for 3±0.5 seconds

•Solder heat resistance

No abnormalities under solder conditions of

leaded process : 230±5°C for 5 seconds

lead free process : 260±5°C for 5 seconds

2. Rinsing

After Soldering, you should rinsing away the excess flux. Any commercially available rinsing agent may be used.

3. Other Precautions

Perform soldering at as low a temperature as possible and for as short a time as possible.

Make sure that the silver electrode of resonators is not covered by solder.

Avoid applying external forces to terminals such as by bending or cutting them.

4. Iron Soldering

Perform iron soldering with iron at following conditions.

Conditins

leaded process : 350±5°C for 5s. Max.

lead free process : 390±5°C for 5s. Max.

1. リフロはんだ条件

• はんだ付け性

フラックス付けした端子部を以下の条件ではんだ中に浸漬し95%以上の面積がはんだで覆われること。

条件

有鉛品 : 230±5°Cのはんだ中に3±0.5秒浸漬

鉛フリー品 : 245±5°Cのはんだ中に3±0.5秒浸漬

• はんだ耐熱性

以下のはんだ付け条件で異常のないこと。

有鉛品 : 230±5°C、5秒間

鉛フリー品 : 260°C、5秒間

2. 洗浄

はんだ付け後のフラックスの洗浄をして下さい。

洗浄液として一般的に使用されている全ての洗浄液が使用できます。

3. その他留意事項

はんだ付けは極力低い温度で短時間で行って下さい。

共振器の銀電極にはんだが付着しないようにして下さい。

端子を曲げたり、切断するなど、端子部分に外力を加えることは避けて下さい。

4. こてはんだ

有鉛半田 : こて先温度350°C以下、加熱時間5秒以内、1回

無鉛半田 : こて先温度390±10°C、加熱時間5秒以内、1回